

97908658 CMV5-10 50 Hz

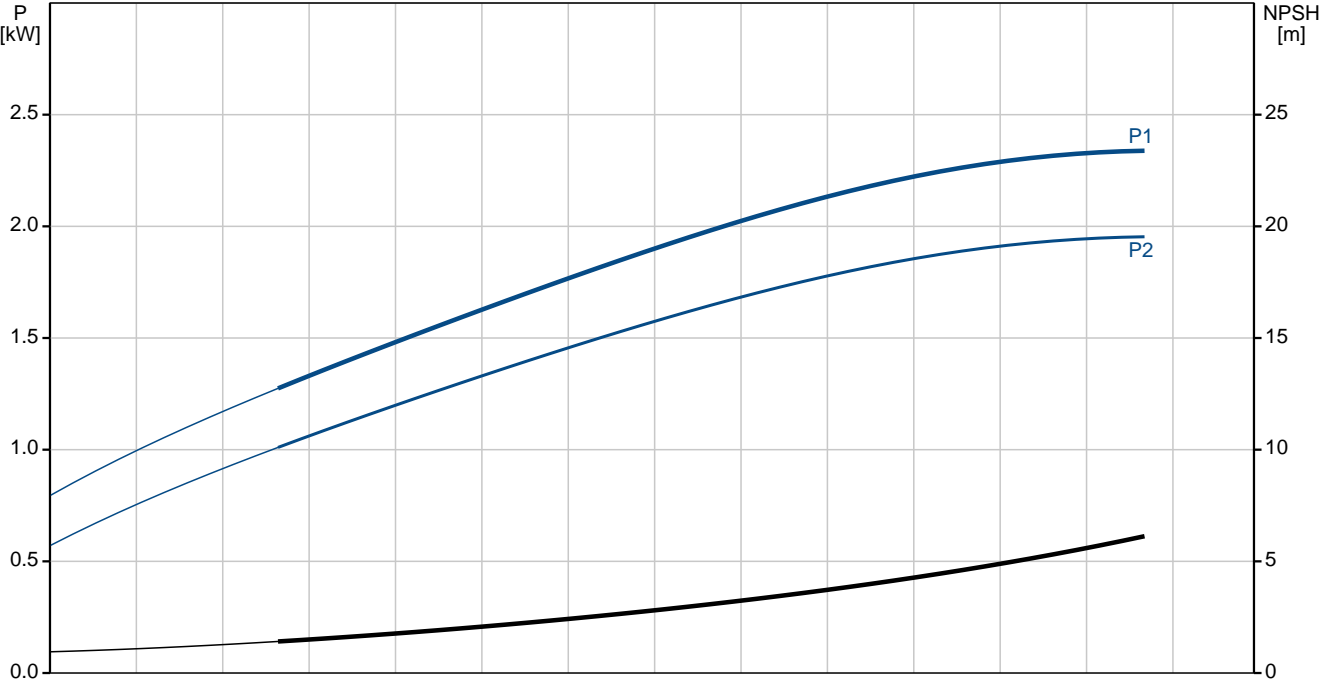
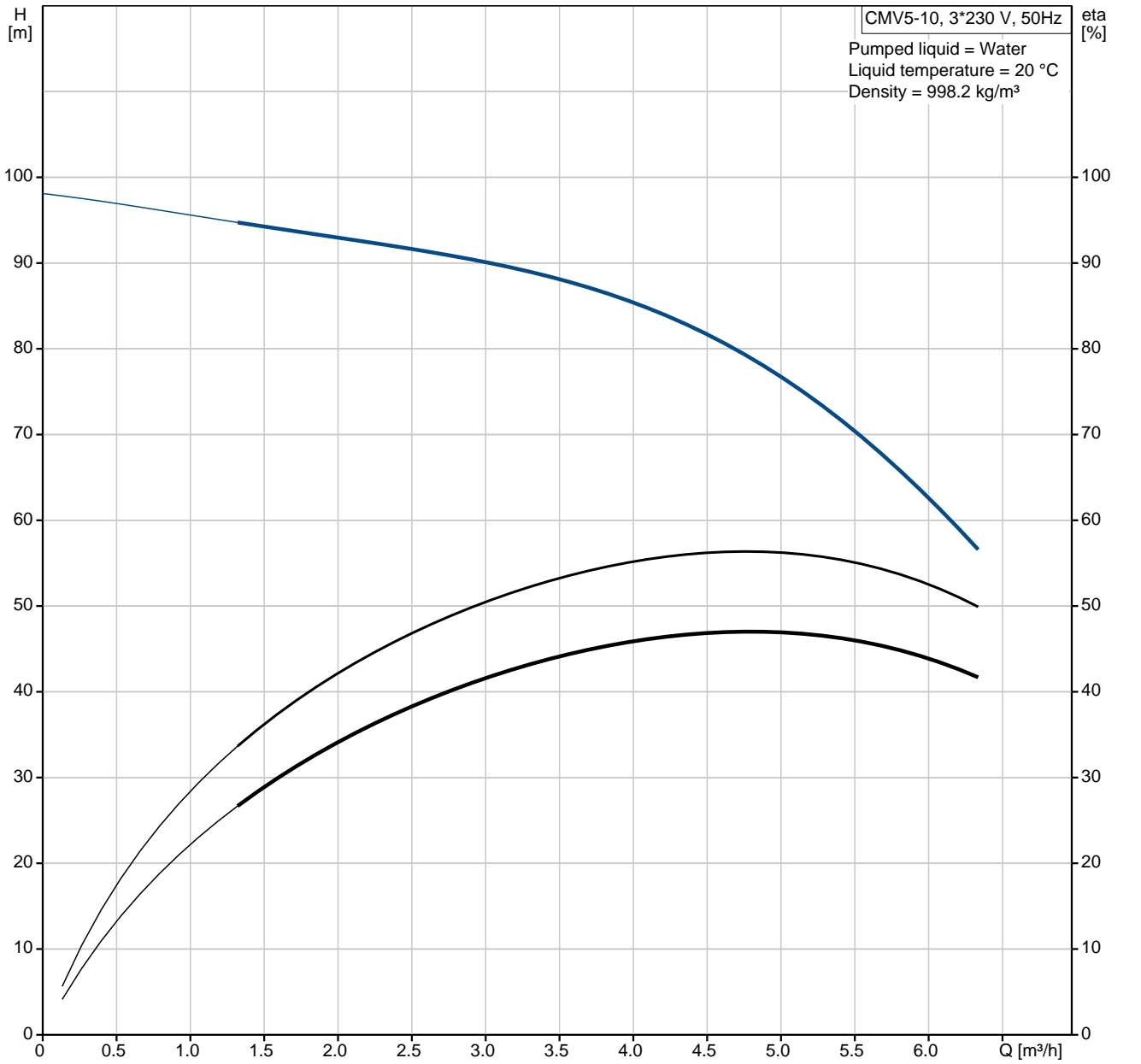

Description	Value
Product name:	CMV5-10 A-R-A-E-AVBE
Product No:	97908658
EAN number:	5710626199662
Price:	On request

Technical:

Speed for pump data:	2900 rpm
Rated flow:	4.7 m³/h
Rated head:	78.2 m
Impellers:	10
Shaft seal:	AVBE
Approvals on nameplate:	CE,ACS
Curve tolerance:	ISO 9906:1999 Annex A
Pump version:	A
Model:	A

Materials:

Pump housing:	Cast iron EN-JL1030 AISI 30 B
Impeller:	Stainless steel DIN W.-Nr. 1.4301 AISI 304
Material code:	A
Rubber:	EPDM
Code for rubber:	E

Installation:

Maximum ambient temperature:	55 °C
Maximum operating pressure:	10 bar
Max pressure at stated temp:	10 bar / 40 °C
Flange standard:	WHITWORTH THREAD RP
Connect code:	R
Pump inlet:	Rp 1 1/4
Pump outlet:	Rp 1

Liquid:

Pumped liquid:	Water
Minimum liquid temperature:	-20 °C
Liquid temp:	20 °C
Density:	998.2 kg/m³
Kinematic viscosity:	1 mm²/s

Electrical data:

IE Efficiency class:	IE2
Rated power - P2:	2.2 kW
Mains frequency:	50 Hz
Rated voltage:	3 x 220-240D/380-415Y V
Service factor:	1
Rated current:	8,15-7,85/4,7-4,5 A
Rated speed:	2880-2910 rpm
Efficiency:	IE2 83,2 %
Motor efficiency at full load:	83,2 %
Enclosure class (IEC 34-5):	IP55
Insulation class (IEC 85):	F
Motor protec:	NO

Others:

Minimum efficiency index, MEI :	0,7
Net weight:	29.5 kg
Gross weight:	32 kg

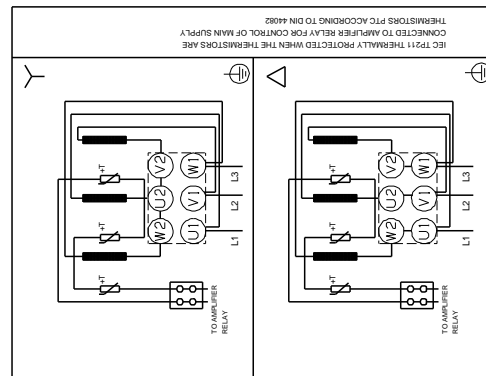
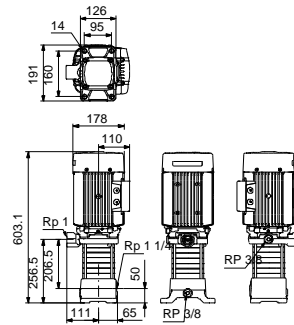
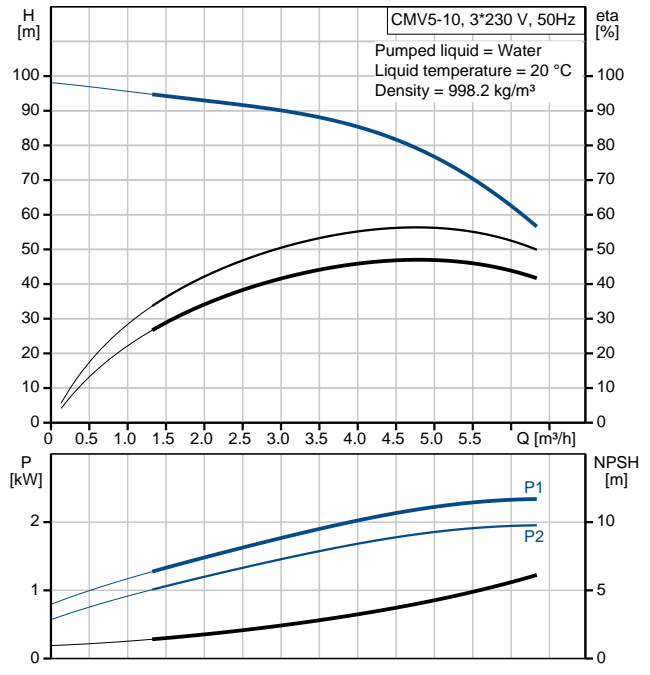

97908658 CMV5-10 50 Hz

CMV5-10 2.2 kW 3*230 V, 50 Hz, SF = 1

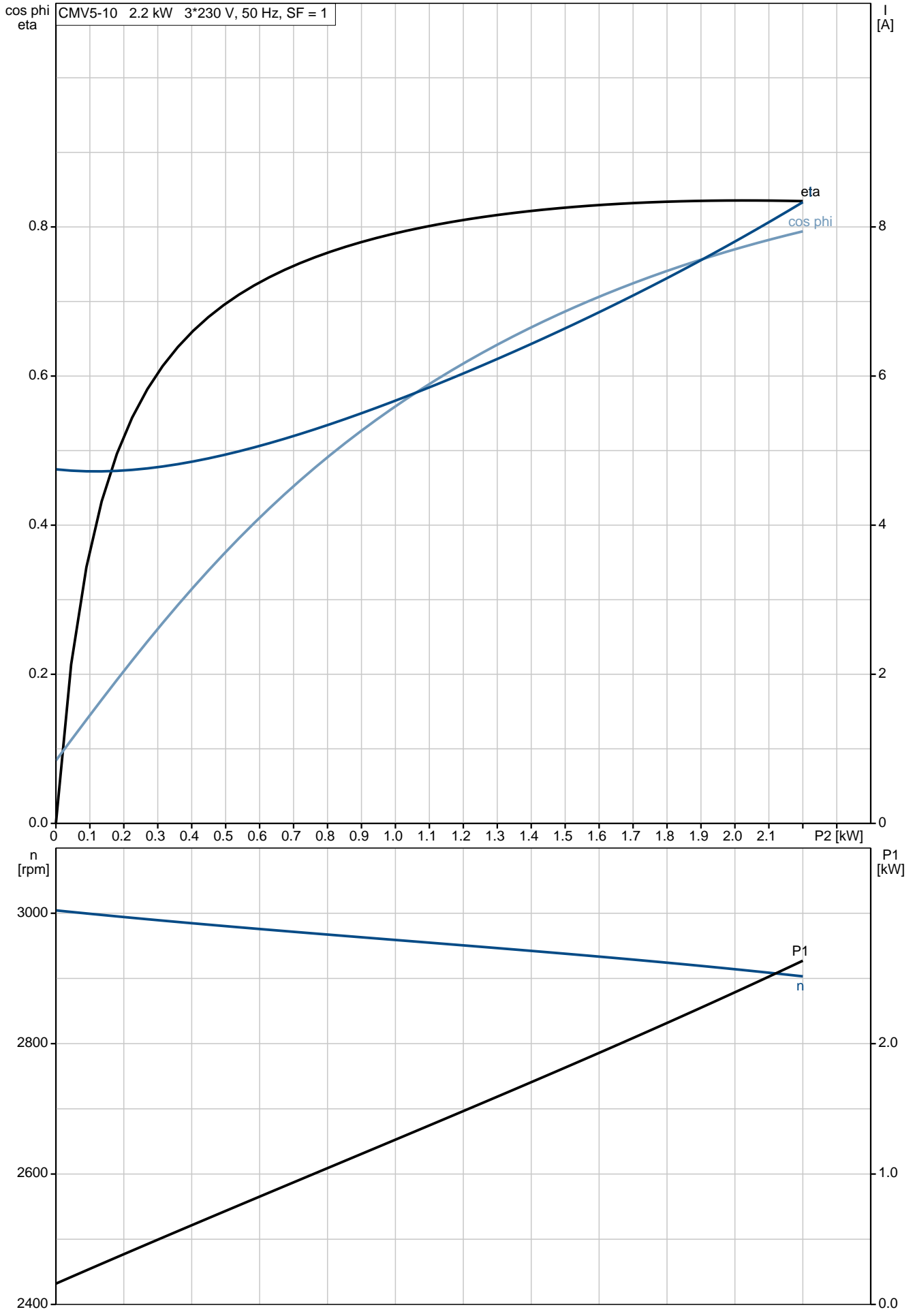

97908658 CMV5-10 50 Hz

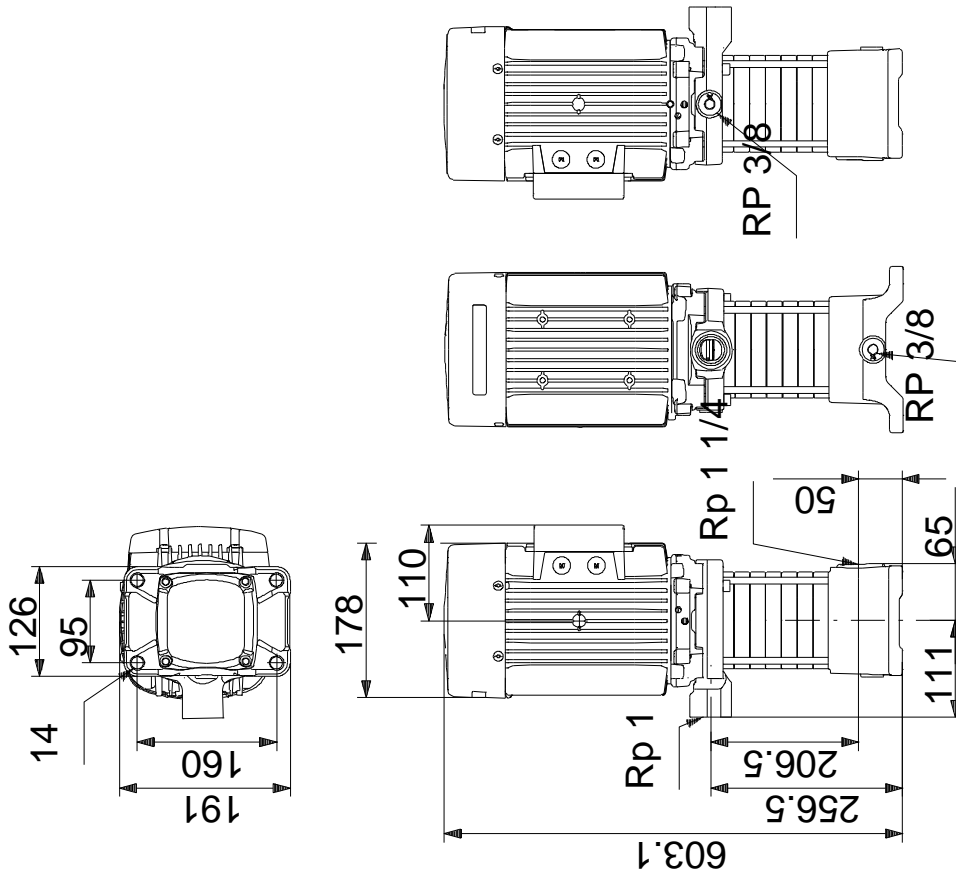

Note! All units are in [mm] unless others are stated.
Disclaimer: This simplified dimensional drawing does not show all details.